

Topic-Comment Frames in HPSG

Gert Webelhuth

Georg-August University Göttingen

November 24, 2006

Gundel 1985, 88

There are two different types of OSV sentences in English:

Topicalization of Focus:

- ▶ primary stress falls on the sentence-initial object

- (1) a. What do you like?
b. BEANS I like

Topicalization of Topic:

- ▶ initial object receives a high pitched accent
- ▶ primary stress falls on some other constituent in the sentence

- (2) a. How do you feel about beans?
b. Beans I LIKE

Fronted objects need not carry any topic or focus pitch accent:

- (3) a. Mich FRIERT.
- b. Mich hat etwas GESTOCHEN.
- c. Mich hat heute jemand vom FINANZAMT angerufen

Overview of this Talk

The Main Goal: to make the difference in form-function correspondence between the 3 English and German fronting constructions displayed above expressible in HPSG.

Difficulties:

1. There is as yet no theory of discourse and information structure in HPSG that is sufficiently comprehensive to capture the usage generalizations of fronting in English and German (good beginnings by Kordula de Kuthy!).

Analytic strategy

1. to associate a semantic representation format with the syntactic machinery of HPSG that allows direct reference to properties
2. to design the semantic representations in such a way that it can capture both
 - 2.1 the truth-conditional content of signs, and
 - 2.2 the way this content is structured into topic and comment and background and focus.

More concretely:

1. choice of semantic representation format: lambda-DRT, plus
2. a watered-down variant of Krifka 1992's theory of topic-comment articulation
3. incorporation of ideas of Sailer, de Kuthy, Jacobs, Büring, and others

The structure of *loc*

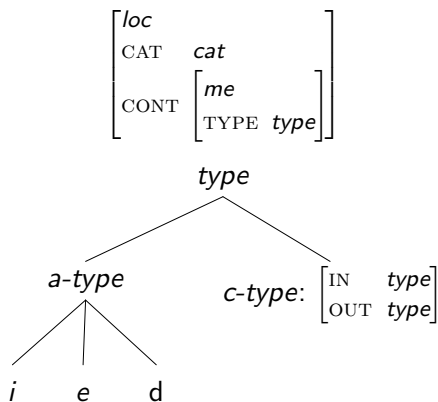

i = individual, *e* = eventuality, *d* = DRS

Subtypes of *me*

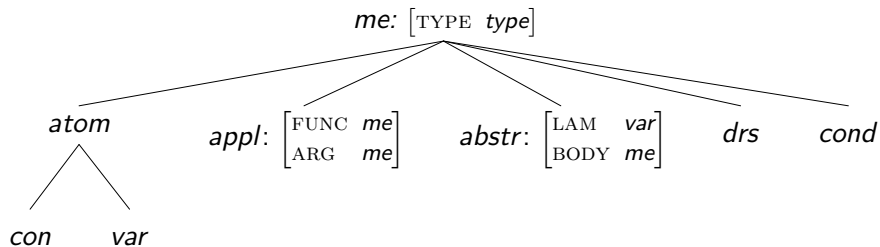

Subtypes of *me*

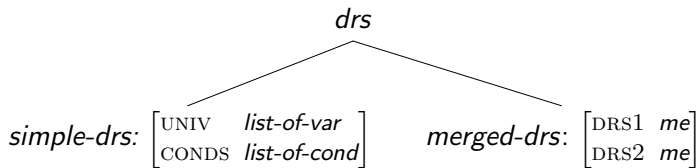

Abbr.: $\boxed{1} + \boxed{2} =_{abbr} \begin{bmatrix} \text{merged-drs} \\ \text{DRS1} \ \boxed{1} \\ \text{DRS2} \ \boxed{2} \end{bmatrix}$

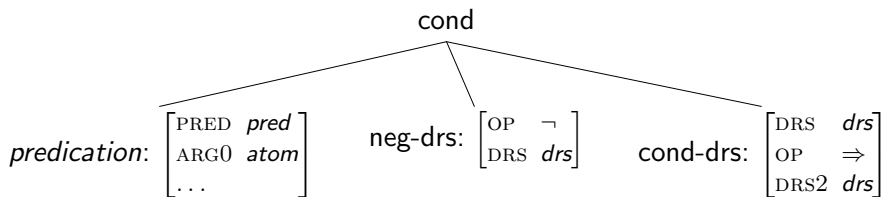

Examples of contents

Fido: $\left[\begin{array}{l} \textit{word} \\ \text{PHON } \langle \textit{fido} \rangle \\ \text{SS } \left[\text{LOC } \left[\text{CONT } \left[\begin{array}{l} \text{TYPE } \textit{i} \\ \textit{fido} \end{array} \right] \right] \right] \end{array} \right]$

- ▶ *fido* is a constant of type *i*.
- ▶ see Muskens 1994, *A Compositional Discourse Representation Theory*.

Examples of contents

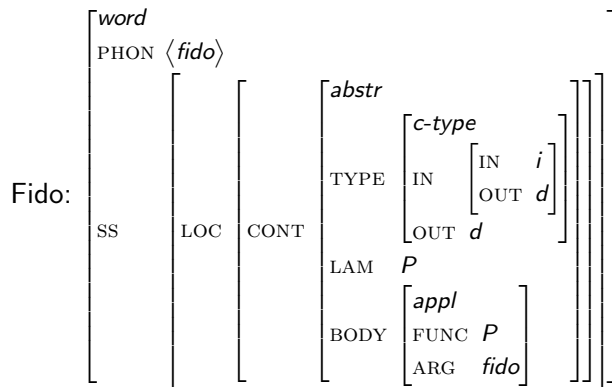

Examples of contents

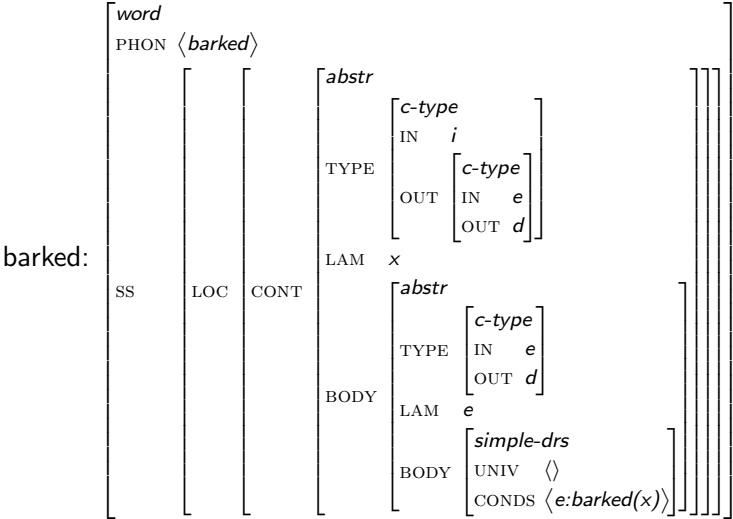

$$[S|L[CONT \text{ apply}(\underline{1}, \underline{2})]]$$
$$[S|L[CONT \underline{1}]]$$
$$[S|L[CONT \underline{2}]]$$
$$\text{apply}(\underline{1} \left[\begin{array}{l} \text{TYPE} \\ \text{IN} \quad \underline{3} \\ \text{OUT} \quad \underline{4} \end{array} \right], \underline{2} \left[\text{TYPE} \quad \underline{3} \right]) = \left[\begin{array}{l} \text{appl} \\ \text{TYPE} \quad \underline{4} \\ \text{FUNC} \quad \underline{1} \\ \text{ARG} \quad \underline{2} \end{array} \right]$$
$$\text{apply}(\underline{2} \left[\text{TYPE} \quad \underline{3} \right], \underline{1} \left[\begin{array}{l} \text{IN} \quad \underline{3} \\ \text{OUT} \quad \underline{4} \end{array} \right]) = \text{apply}(\underline{1}, \underline{2}).$$

Binding of the event variable

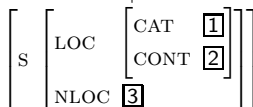
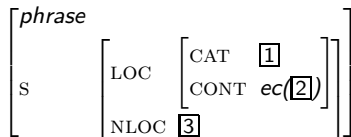

$$\textit{ec} \left(\begin{array}{c} \text{TYPE|OUT}^* \\ \lambda x_1 \dots x_n \lambda eD \end{array} \left[\begin{array}{c} \text{IN} \quad e' \\ \text{OUT} \quad d \end{array} \right] \right) = \left[\lambda y_1 \dots y_n \left(\begin{array}{c} e' \\ \boxed{} \end{array} + \lambda x_1 \dots x_n \lambda eD (y_1 \dots y_n, e') \right) \right]$$

Existential closure of *barked*

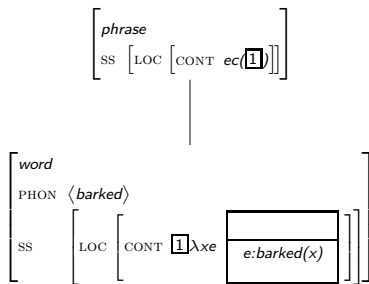

Existential closure of *barked*,2

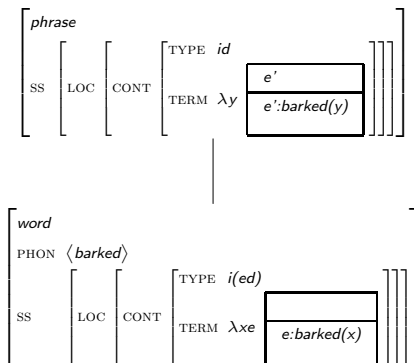

Function-argument application:

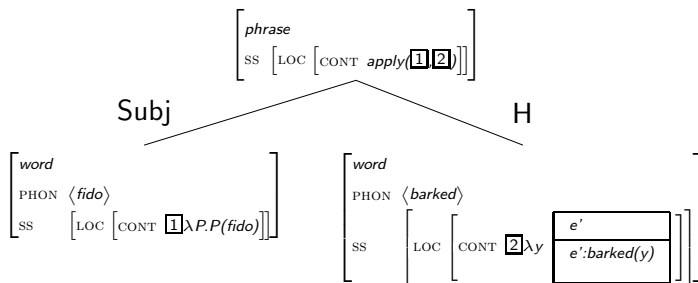

$\text{apply}(\lambda P.P(\text{fido}), \lambda y$

e'
$e':\text{barked}(y)$

$) =$

appl		
FUNC $\lambda P.P(\text{fido})$		
ARG λy		
<table border="1" data-bbox="647 536 869 702"><tr><td>e'</td></tr><tr><td>$e':\text{barked}(y)$</td></tr></table>	e'	$e':\text{barked}(y)$
e'		
$e':\text{barked}(y)$		

which reduces to

e'
$e':\text{barked}(\text{fido})$

Krifka 1992:

- ▶ The content of a sentence is structured into a topic and a comment.
- ▶ Both topic and comment may themselves be structured into background and focus to signal that the topic or comment is considered in contrast to a set of salient comparable alternatives in the context of utterance.

The truth-functional contribution of a sign is obtained from its information structure as follows:

1. For background and focus: apply the background to the focus.
2. For the information structure as a whole: apply the comment to the topic.

This means that the background of the comment contains bound variables “representing” the focus of the comment and the topic!

Examples of informationally structured expressions

General structure:

istr: $\langle comm, top \rangle$ cont: comm(top).

Example: $[_{top} \text{Fido}] [_{comm} \text{BARKED}]$

istr: $\langle \lambda x_i. bark(x), fido_i \rangle$ cont: bark(fido).

Example: $[_{comm} \text{FIDO}] [_{top} \text{barked}]$

istr: $\langle \lambda P_{id}. P(fido), \lambda x_i. bark(x) \rangle$ cont: bark(fido).

Examples of informationally structured expressions, 2

The comment and the topic may each be structured into background and focus:

istr: $\langle \langle \text{comm } \text{bg}_{\text{comm}}, \text{foc}_{\text{comm}} \rangle, \langle \text{top } \text{bg}_{\text{top}}, \text{foc}_{\text{top}} \rangle \rangle$

cont: $[(\text{bg}_{\text{comm}}(\text{foc}_{\text{comm}}))(\text{bg}_{\text{top}}(\text{foc}_{\text{top}}))]$

Example: $[[\text{contr-top SANDY}] [\text{comm } [\text{ncontr likes}] [\text{contr JILL}]]]$

istr: $\langle \langle \lambda z \lambda x. \text{likes}(x,z), \text{jill} \rangle, \langle \lambda v_j. v, \text{sandy} \rangle \rangle$

Truth-functional content:

$[\lambda z \lambda x. \text{likes}(x,z)](\text{jill}) = \lambda x. \text{likes}(x, \text{jill})$

$[\lambda v_j. v](\text{sandy}) = \text{sandy}$

$[\lambda x. \text{likes}(x, \text{jill})](\text{sandy}) = \text{likes}(\text{sandy}, \text{jill}).$

Adding features to *loc* to create an information structure

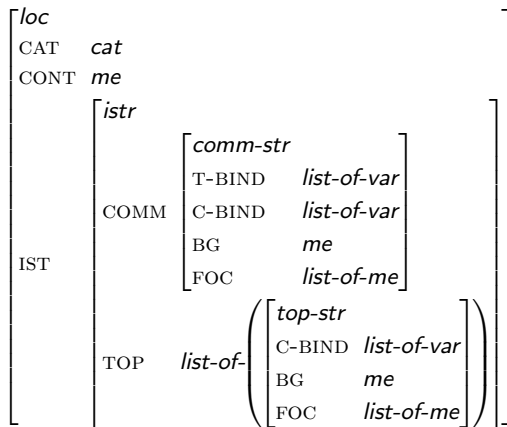

Some types and constraints

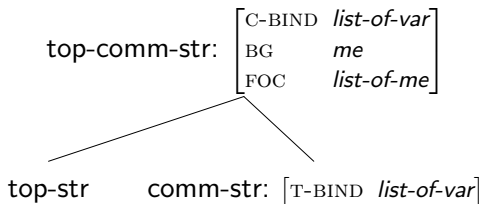

The Contrast Constraint In every feature structure of type *top-comm-str*, there is a bijective relationship between the c-bound variables inside the value of BG and the members of FOC

The Topic Constraint In every feature structure of type *istr*, there is a bijective relationship between the t-bound variables inside the value of COMM|BG and the members of TOP

Subtypes of *istr*

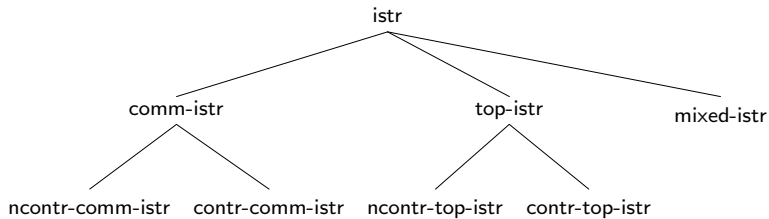

Constraint on *comm-istr*

comm-istr \rightarrow [TOP $\langle \rangle$]

Example: $\left[\begin{array}{l} \text{COMM} \left[\begin{array}{l} \text{T-BIND} \langle \rangle \\ \text{C-BIND} \langle \rangle \\ \text{BG} \quad \textit{fido} \\ \text{FOC} \quad \langle \rangle \end{array} \right] \\ \text{TOP} \langle \rangle \end{array} \right]$

Constraint on *top-istr*

top-istr \rightarrow [TOP *ne-list*]

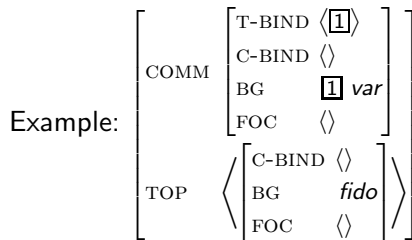

The *mixed-istr* Constraint If the ISTR of a phrase is of type *mixed-istr*, then either (A) the phrase has one daughter whose ISTR is of type *top-ist* and another one whose ISTR is of type *comm-ist* or (B) the phrase has a daughter whose ISTR is of type *mixed-istr* or

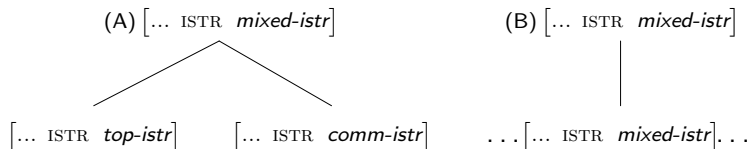

The Phrasal Uniformity Constraint If the ISTR of a phrase is of type τ , for τ a subtype of *comm-istr* or *top-istr*, then the ISTR of each daughter likewise is of type τ .

$$[S|L|ISTR (\tau \wedge \textit{comm-istr}) \vee (\tau \wedge \textit{top-istr})]$$

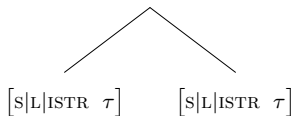

Principles for computing the ISTR of phrases

General case:

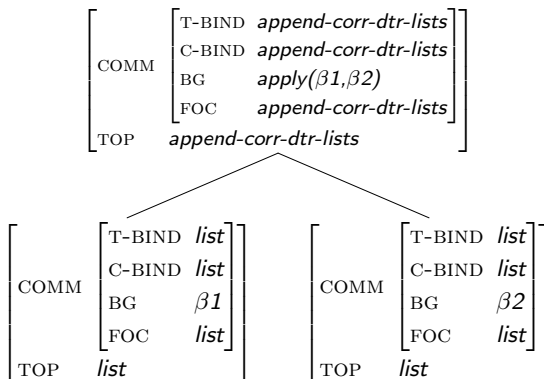

Principles for computing the ISTR of phrases, 2

Special case 1: both daughters have a c-bound background:

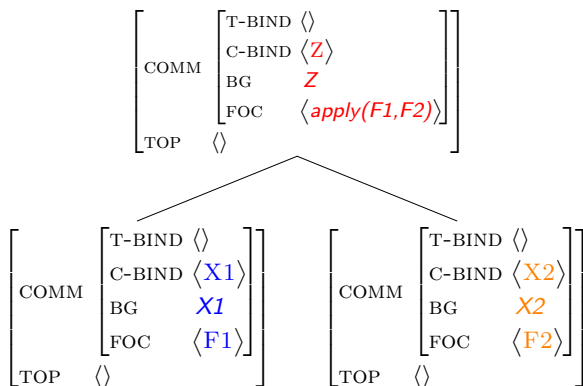

Principles for computing the ISTR of phrases, 3

Special case 2: both daughters have a t-bound background:

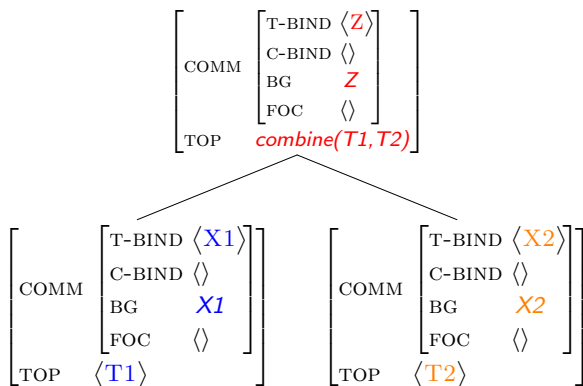

Principles for computing the ISTR of phrases, 4

Special case 3: Head-filler phrases

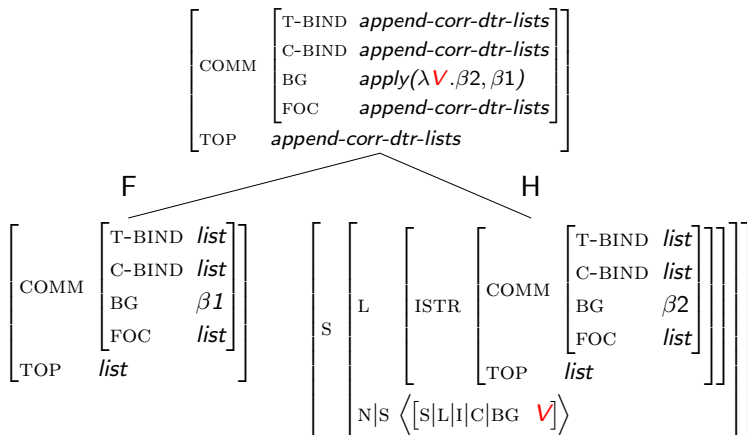

Derivation of A GREEN light you IGNORE

Text: A RED light you stop the MACHINE. A GREEN light you IGNORE.

Assumptions:

[s [top A GREEN_{loc} light]_i [comm you IGNORE_{loc} t_i]]

Desired topic-comment structure:

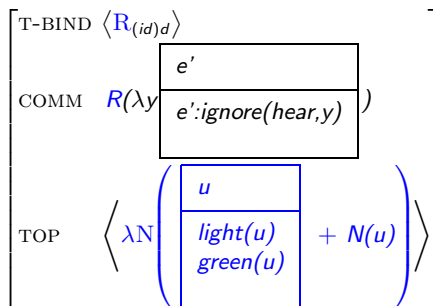

The Fronting Construction

front-ph \implies

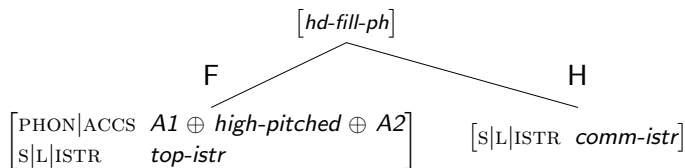

Constraint The nuclear accent of an expression is contributed by a subexpression whose ISTR is of type *comm-istr*.

Derivation of A GREEN light you IGNORE, 2

$$[t]: \left[\begin{array}{l} \text{COMM} \\ \text{TOP} \end{array} \left[\begin{array}{l} \text{T-BIND } \langle \rangle \\ \text{C-BIND } \langle \rangle \\ \text{BG} \left[\begin{array}{l} \mathbf{q1} \\ \text{TYPE } \mathbf{q} \end{array} \right] \\ \text{FOC } \langle \rangle \end{array} \right] \right]$$

Derivation of A GREEN light you IGNORE, 3

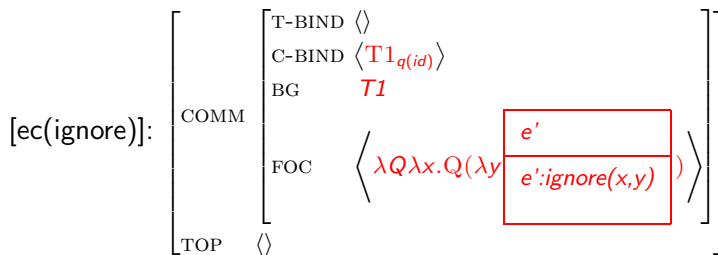
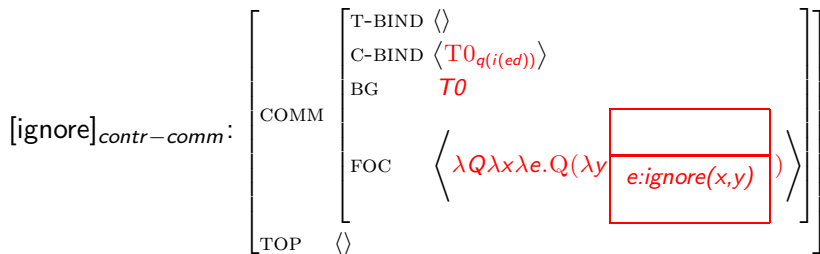

Derivation of A GREEN light you IGNORE, 4

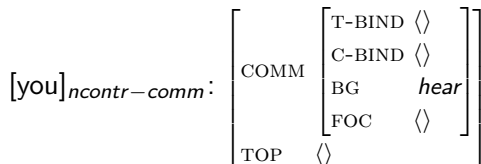
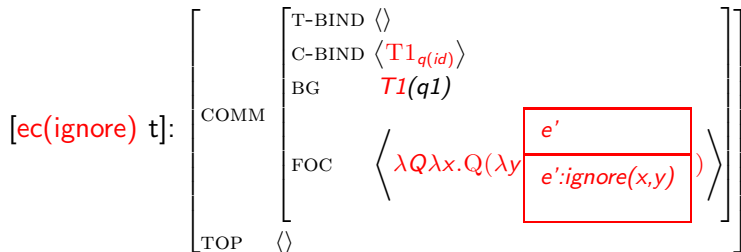

Derivation of A GREEN light you IGNORE, 5

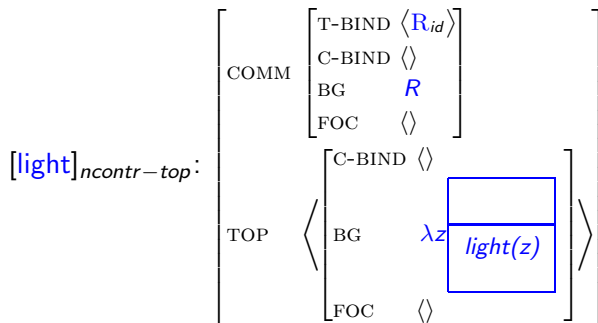
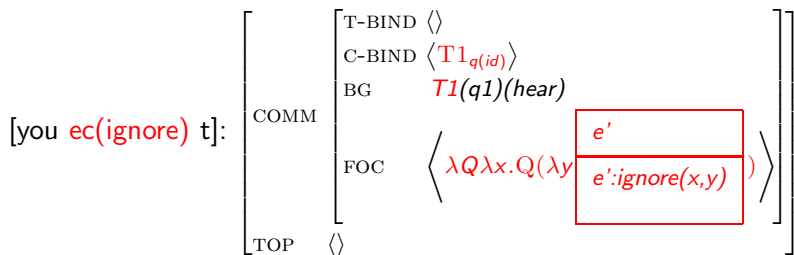

Derivation of A *GREEN* light you *IGNORE*, 6

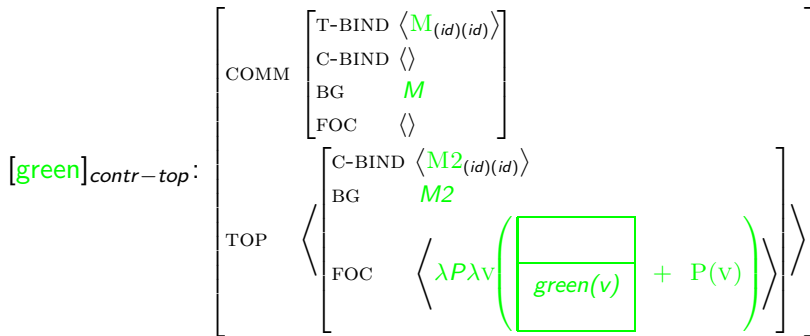

Derivation of A GREEN light you IGNORE, 7

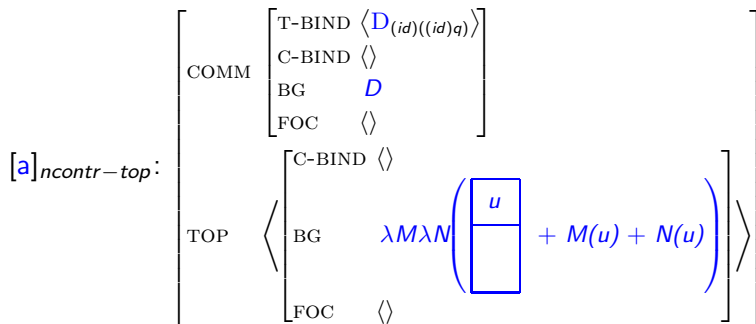

Derivation of A GREEN light you IGNORE, 8

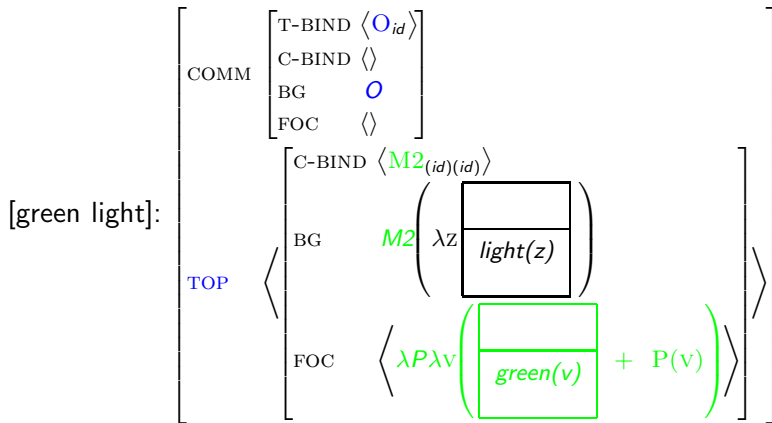

Derivation of A GREEN light you IGNORE, 9

[a green light]:

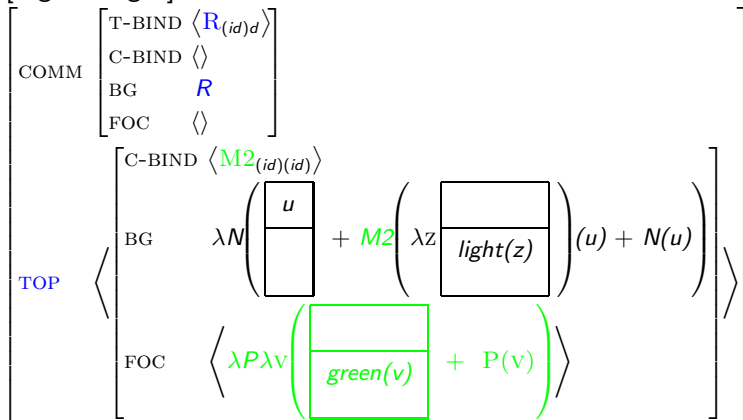

Derivation of A GREEN light you IGNORE, 10

[a green light you ec(ignore) t]:

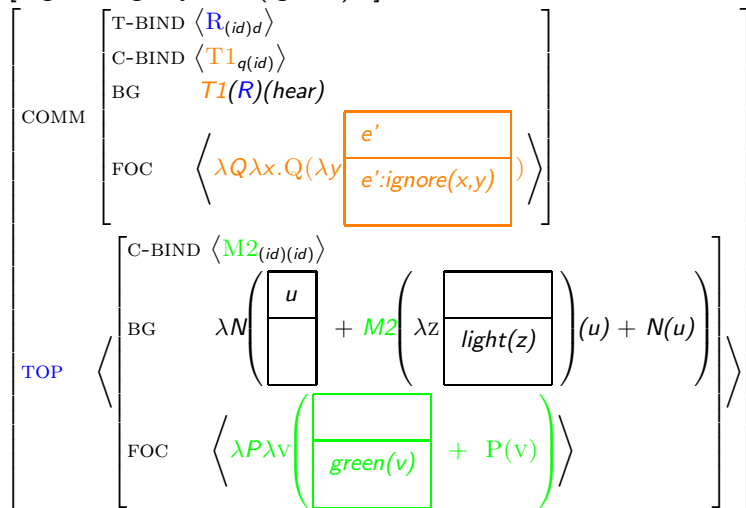

[a green light you ec(ignore) t]:

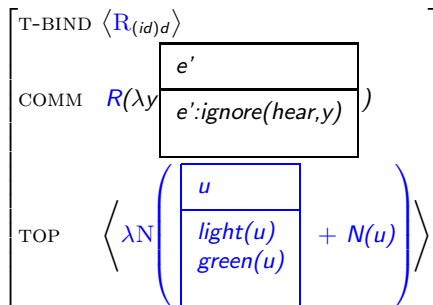

What we (hopefully) have:

an HPSG syntax that

- ▶ compositionally derives discourse representation structures
- ▶ stratified into topic-comment and background-focus

What this framework can (hopefully) be used for:

to capture the rich dependencies between

- ▶ sentence form
- ▶ sentence meaning, and
- ▶ information structure.

The End